

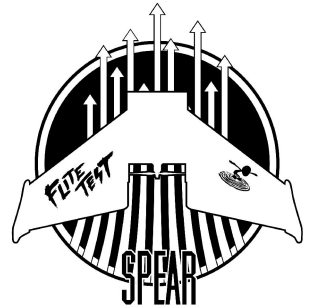

www.flitetest.com

FT Spear

Designed By: Josh Bixler
 Drawing By: Dan Sponholz



SPECIFICATIONS

DESCRIPTION		IMPERIAL	METRIC
LENGTH		20.5 in	521 mm
CENTER OF GRAVITY	CG	3.0 - 3.5 in	76 - 89 mm
WING SPAN		41.0 in	1041 mm
WING AREA		435 in ²	28.1 dm ²
DRY WEIGHT		23.20 oz	658 g
ALL UP WEIGHT	AUW	29.9 oz	848 g
WING LOADING	WL	9.9 oz/ft ²	30.2 g/dm ²
WING CUBIC LOADING	WCL	5.7	

RECOMMENDED SETTINGS

	THROW	EXPO
ELEVONS	16°	30%
REFLEX	8.5°	

Build Skill Level :



Pilot Skill Level :



SHEET & TILE KEY

1	2	3	4
5	6	7	8

9	10	11	12
13	14	15	16

17	18	19	20
21	22	23	24

25	26	27	28
29	30	31	32

33	34	35	36
37	38	39	40



DRAWING KEY

FOLD TYPES

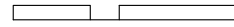
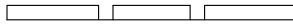
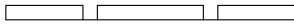
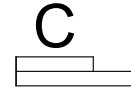
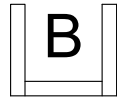
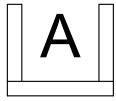

A - FOLD (ABOVE)

B - FOLD (BESIDE)

C - FOLD (COVER)

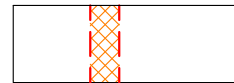
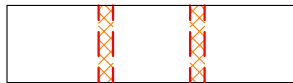
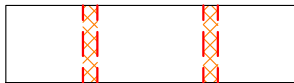

LINE TYPE/COLOR

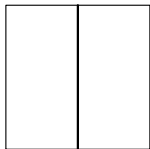

CUT

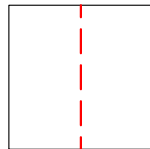

50% SCORE

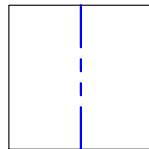
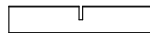

CREASE

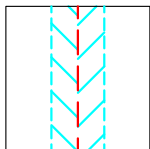

45° DOUBLE BEVEL

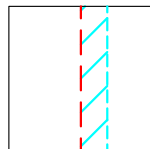

45° SINGLE BEVEL

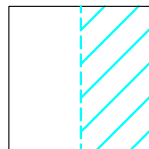

EDGE BEVEL

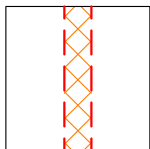

CAVITY

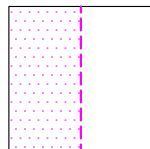

REMOVE PAPER

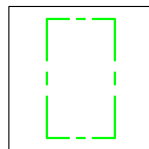
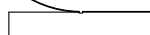

REFERENCE/
OPTIONAL

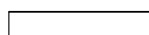

SYMBOLS

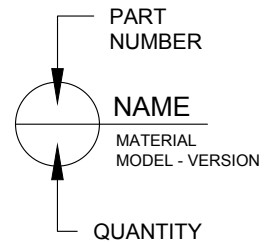

DOWEL HOLE



CENTER OF GRAVITY (CG)

FT Spear

Designed By: Josh Bixler
Drawing By: Dan Sponholz

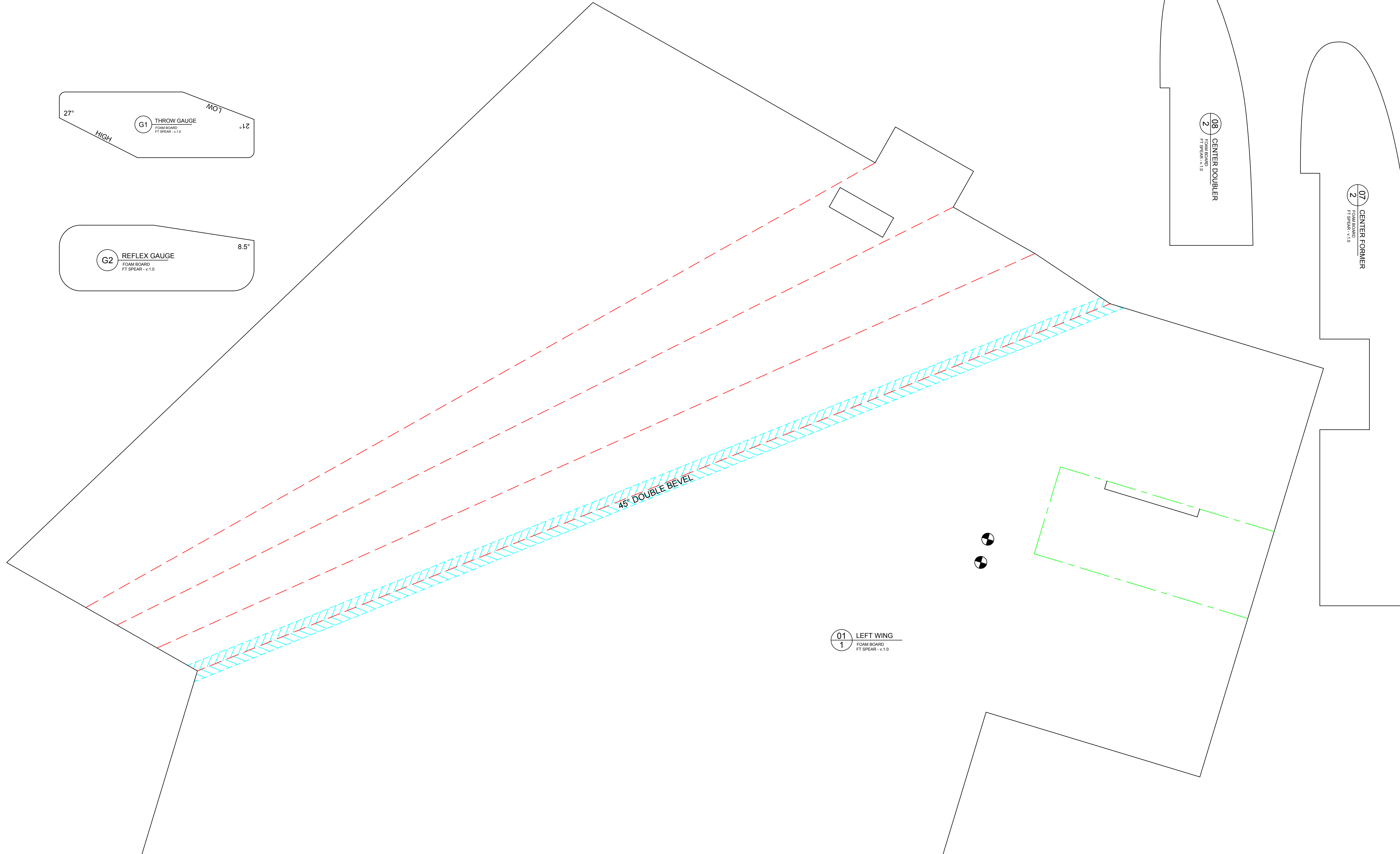
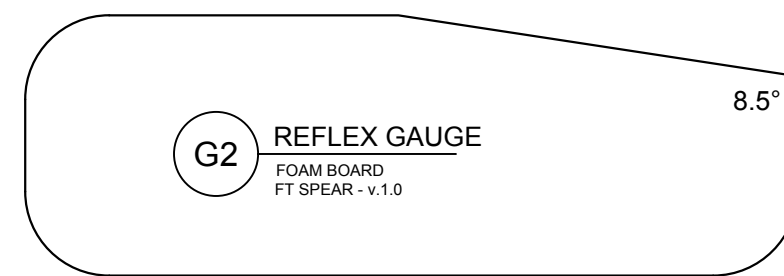
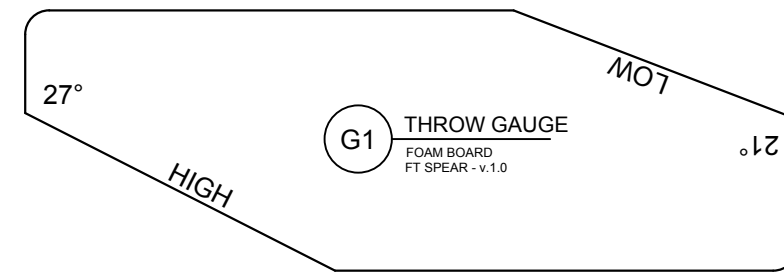

FT Spear

Designed By: Josh Bixler
Drawing By: Dan Sponholz

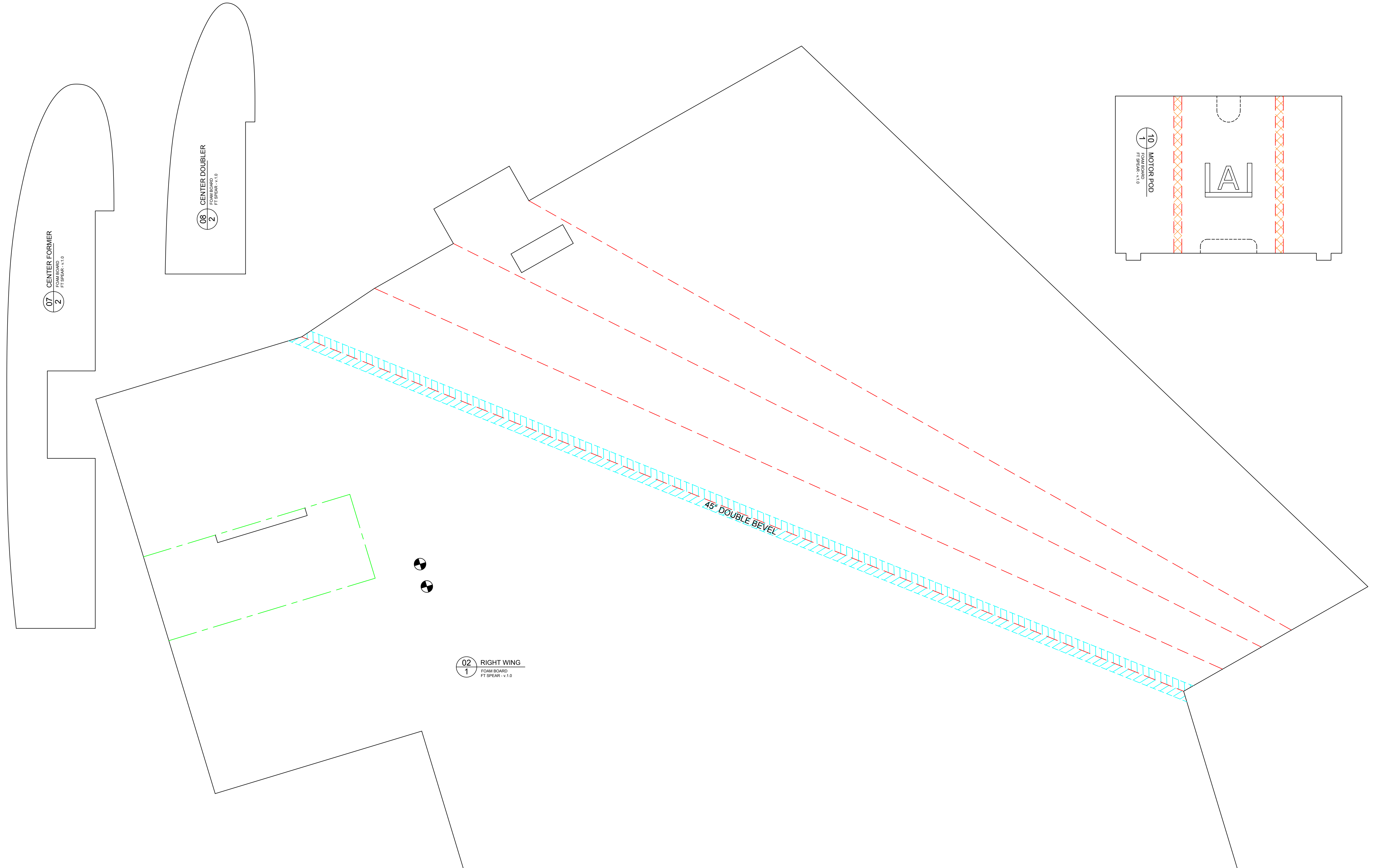

FT Spear

Designed By: Josh Bixler
Drawing By: Dan Sponholz

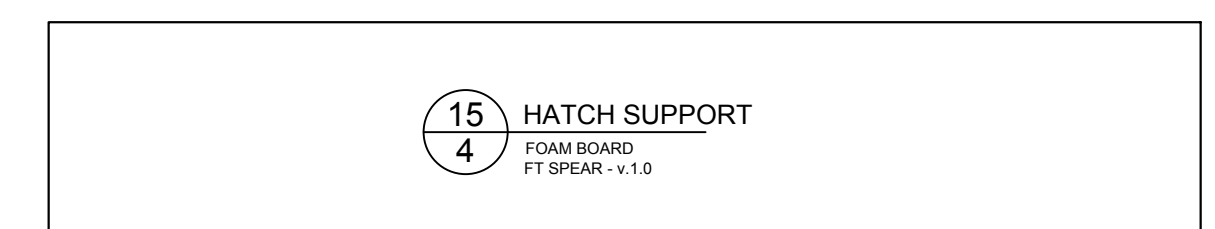
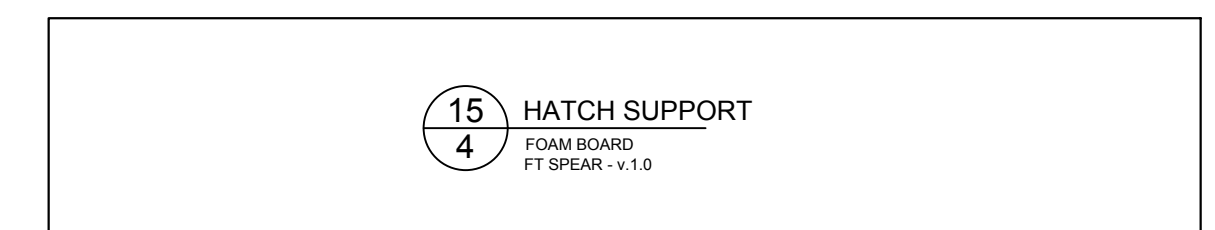
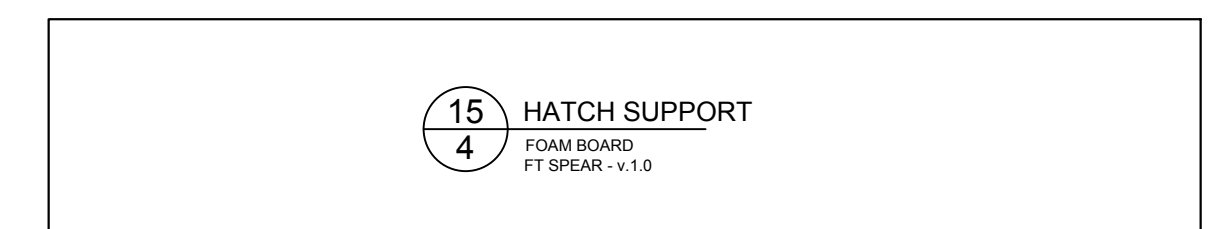
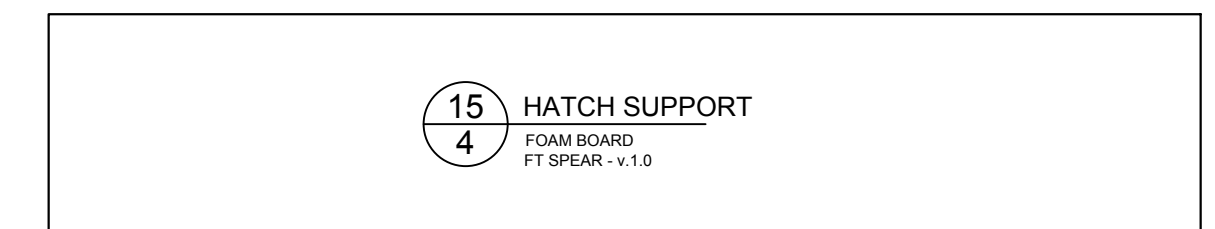
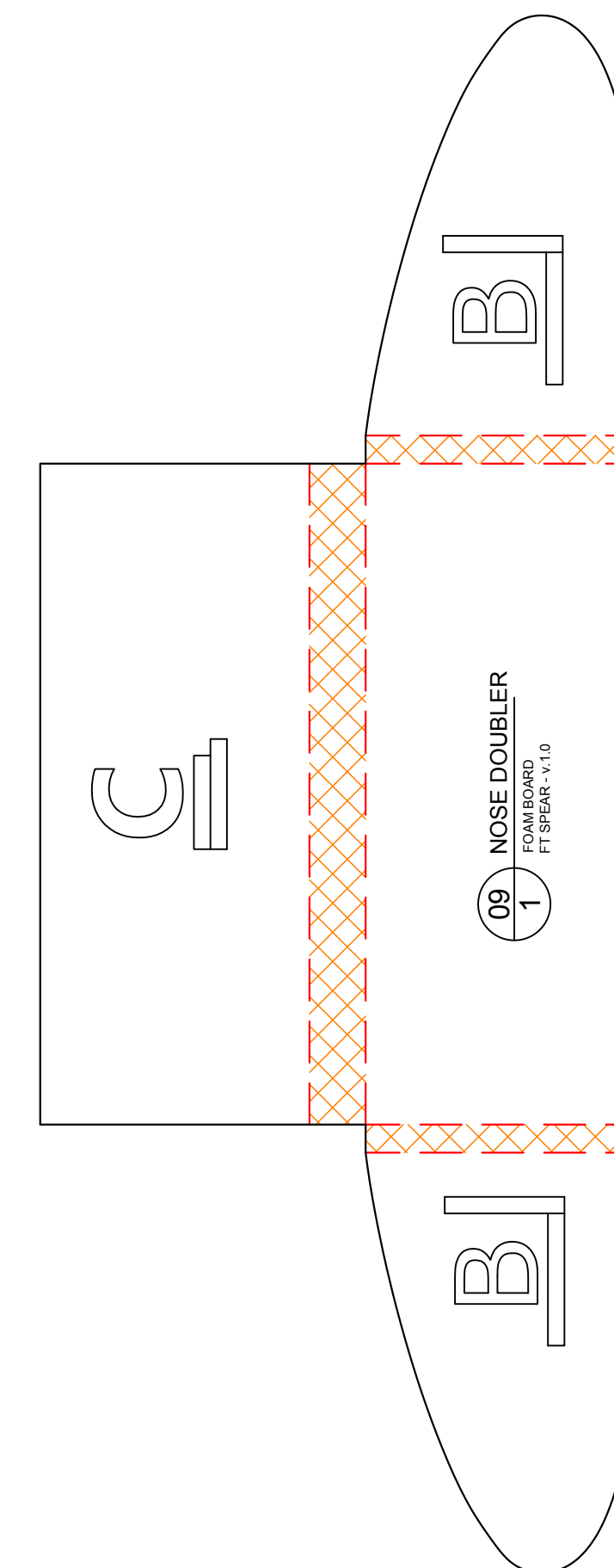
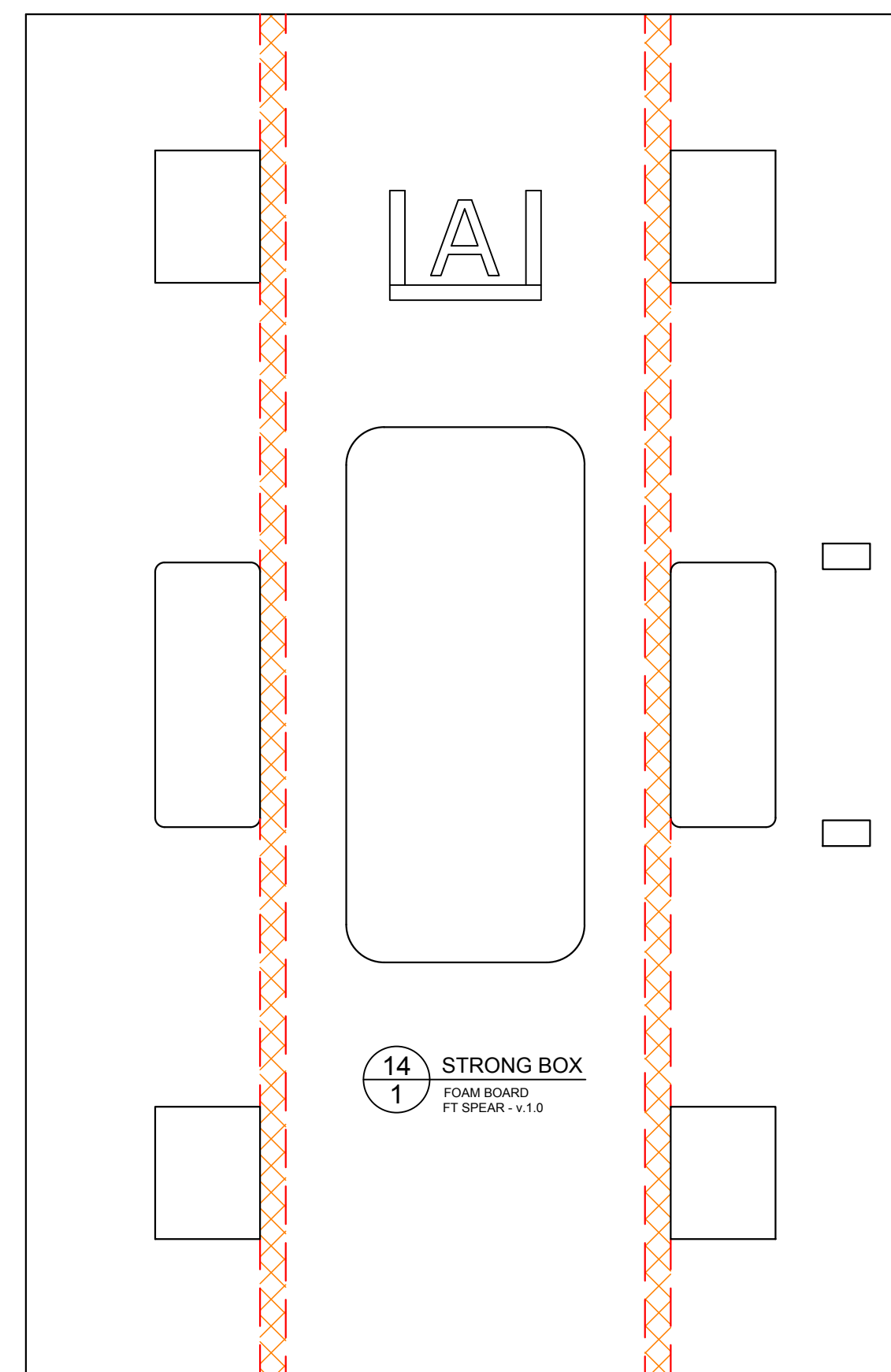
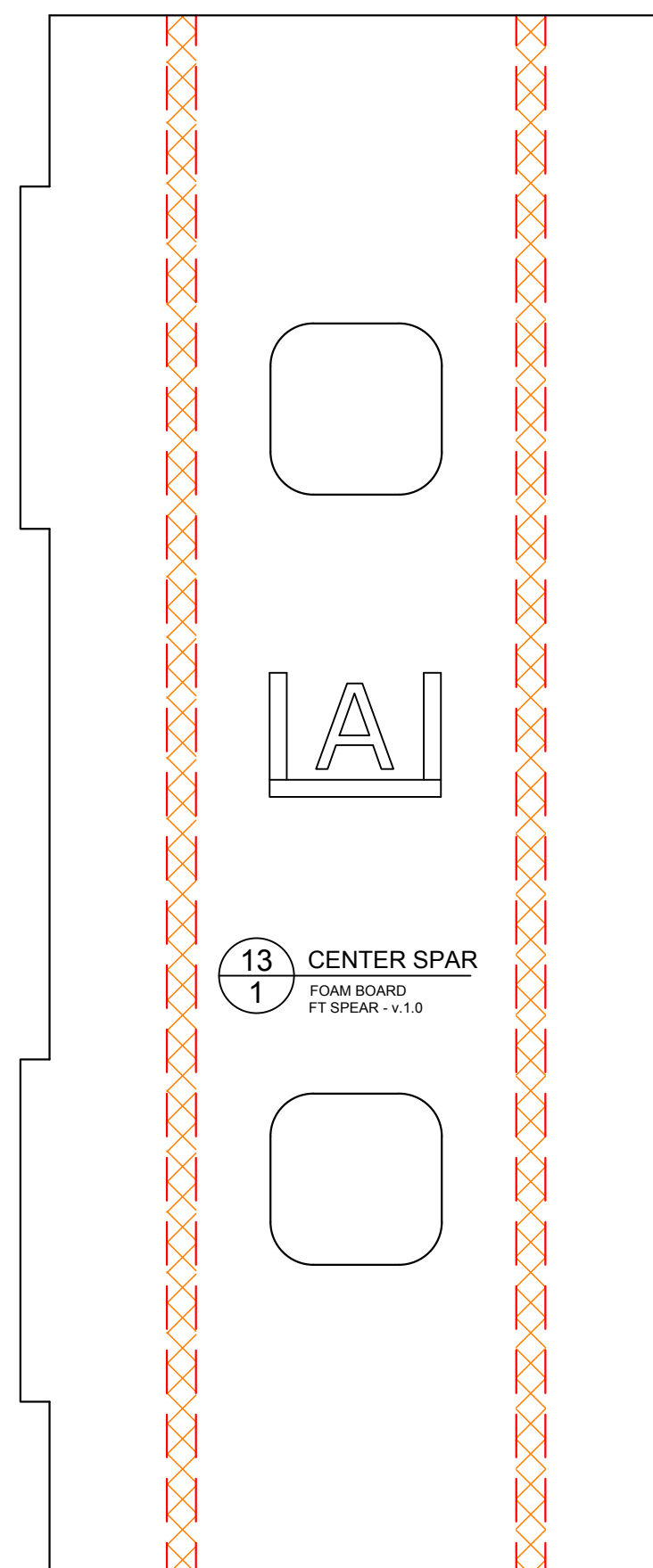
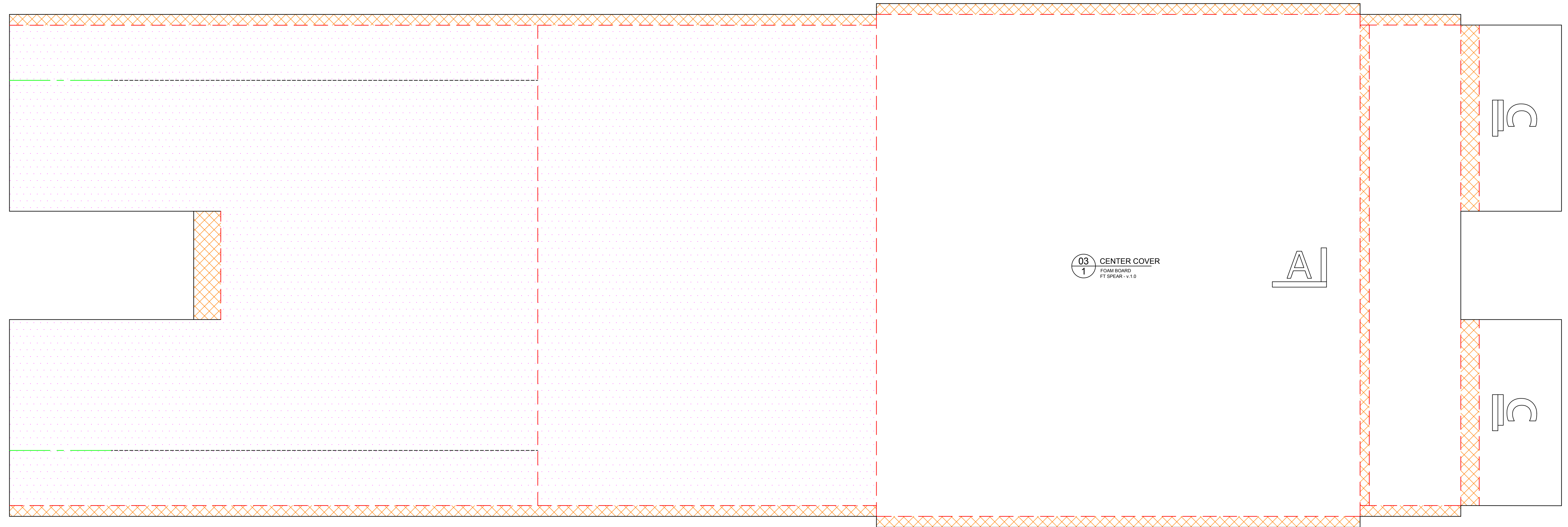

FT Spear

Designed By: Josh Bixler
Drawing By: Dan Sponholz

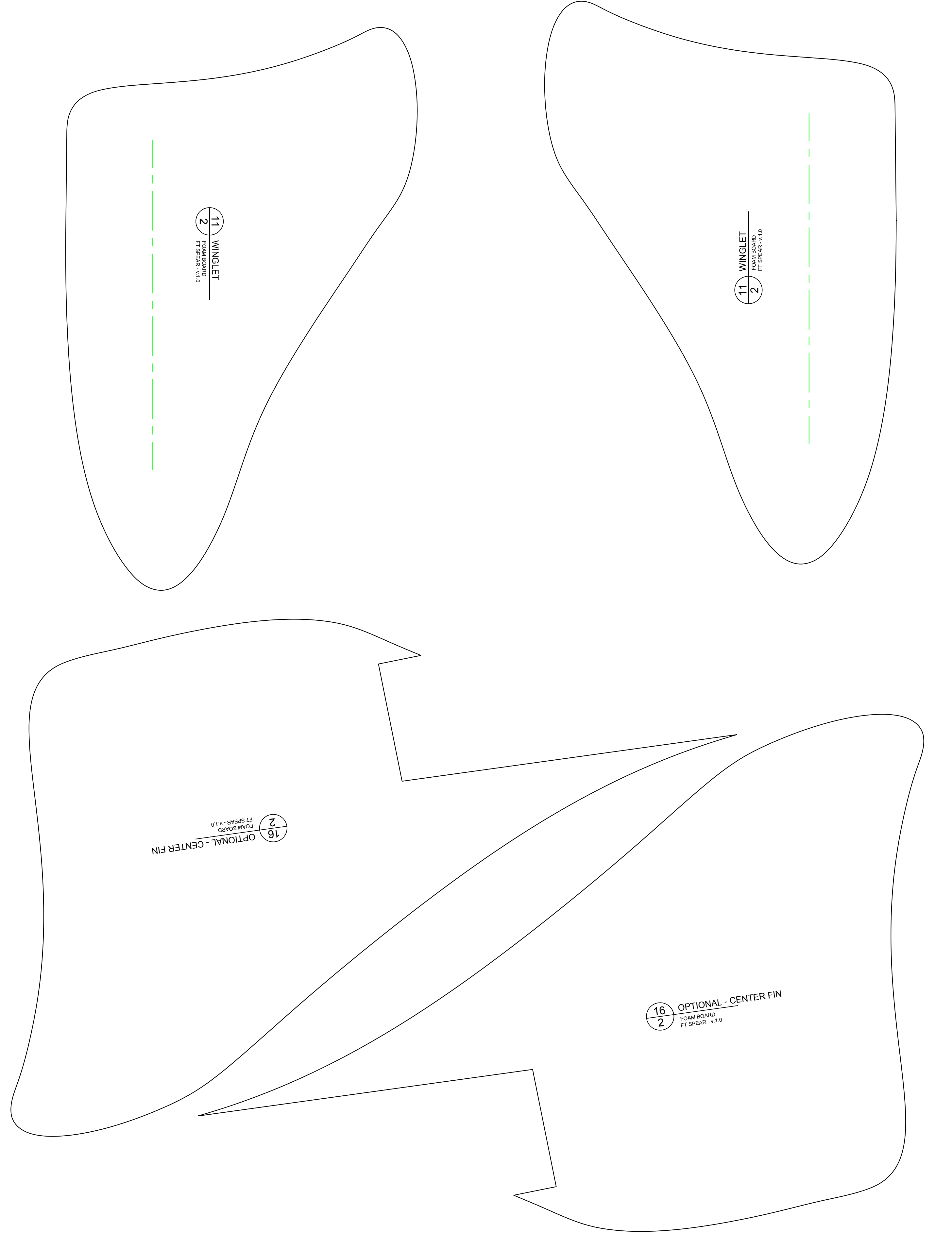
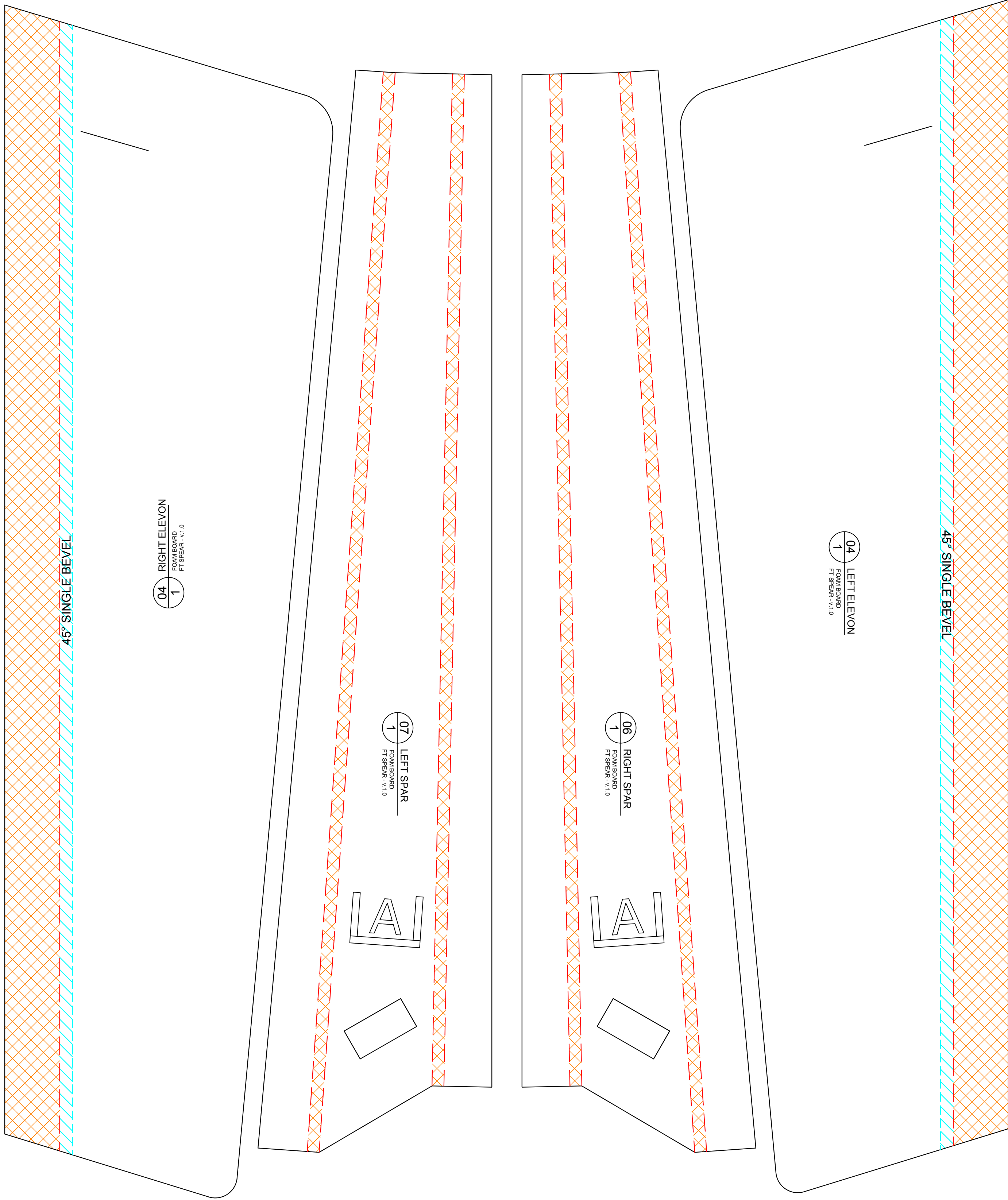

FT Spear

Designed By: Josh Bixler
Drawing By: Dan Sponholz

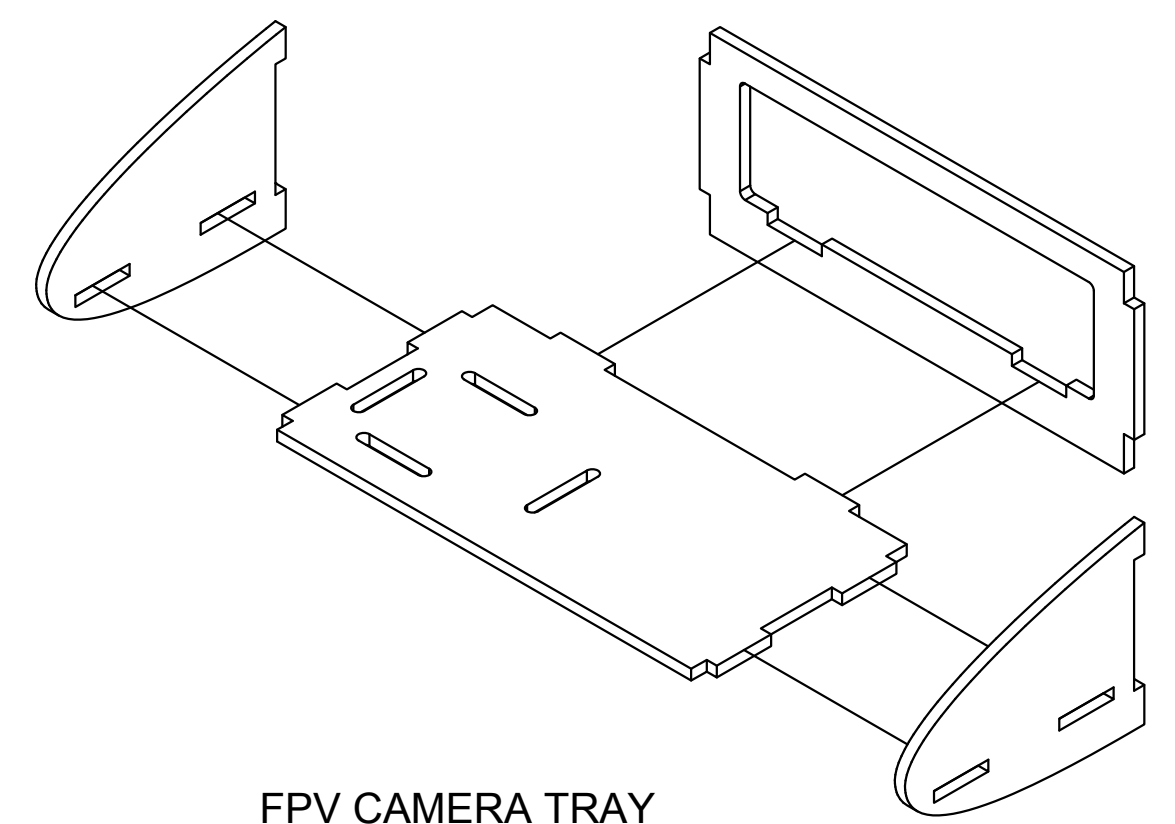
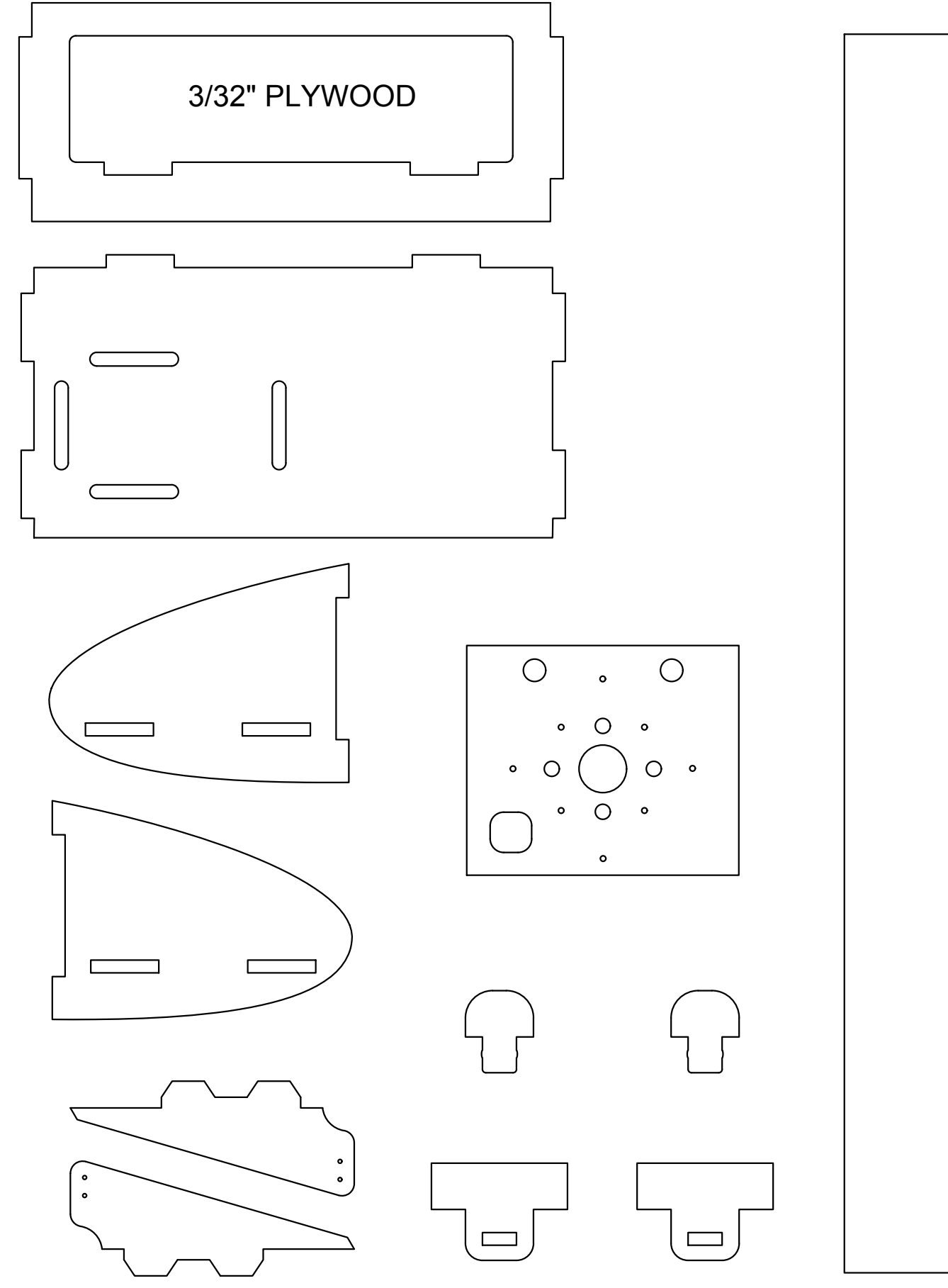

FPV CAMERA TRAY
EXPLODED ASSEMBLY